

SHOWERS

SHOWERS SELECTION

ARBLU ABOUT BATHROOM

Showers selection

La stanza da bagno nella sua interezza.

Arblu definisce **il bagno in ogni sua parte.**
Struttura il progetto garantendo equilibrio ed efficacia.



EN The bathroom in its entirety. Arblu defines the bathroom in all its parts. Structures the project ensuring balance and efficacy.

DE Das Bad in seiner vollkommenen Gesamtheit. Arblu definiert das Bad in allen Details. Vollkommene Effizienz beim Planen, durch Ausgewogenheit und Wirksamkeit wird eine einmalige Badambiente garantiert.

FR La salle de bain dans son intégrité. Arblu définit chaque partie de la salle de bain et structure le projet en garantissant équilibre et efficacité.

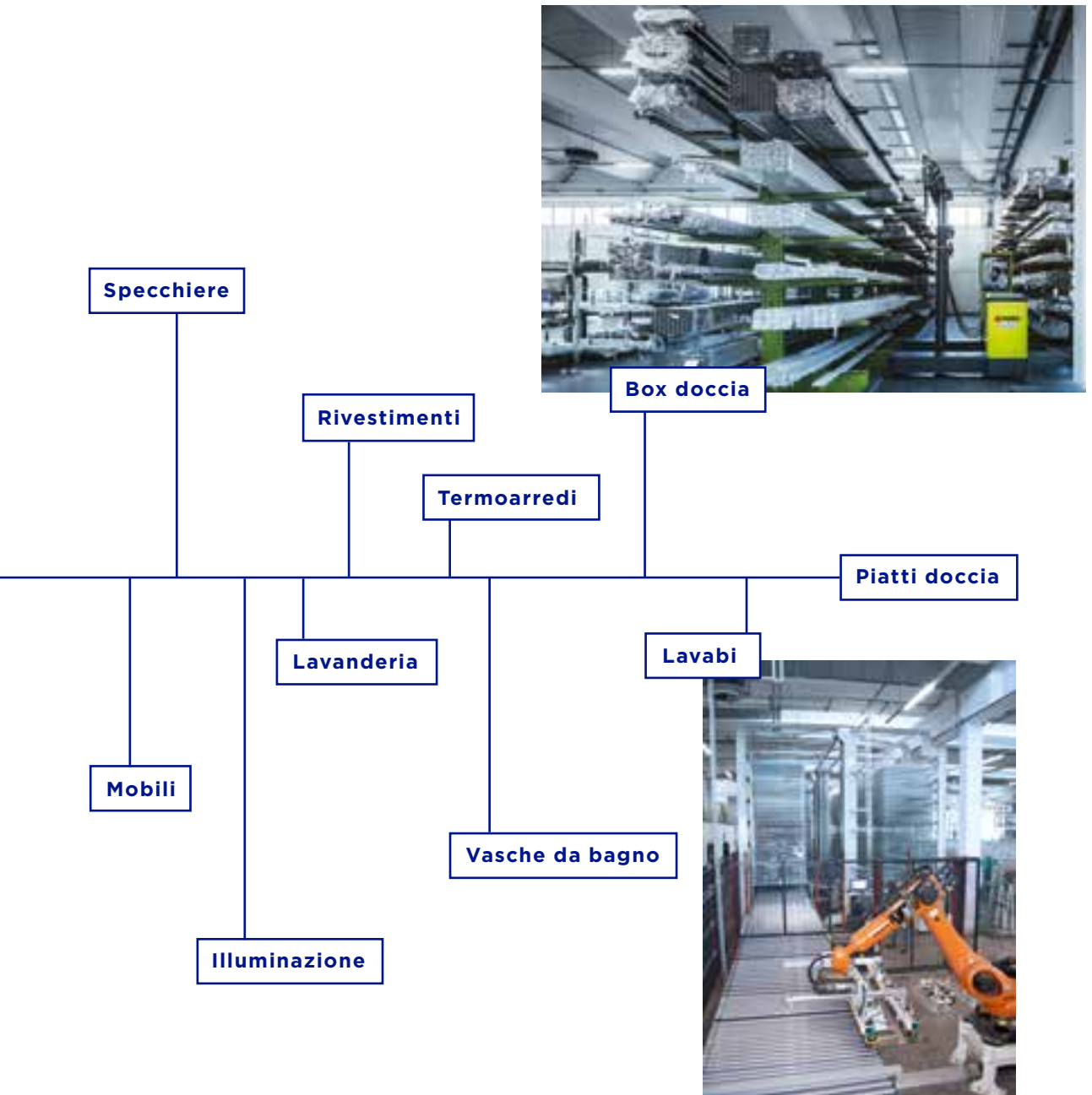

EN Mirrors / Wall coverings /
Decorative radiator / Shower
trays / Furniture / Lighting /
Laundry / Bath tubs /
Washbasin / Shower cabin

DE Spiegel / Wandpaneele /
Moderne Design Heizkörper /
Duschwannen / Möbel /
Beleuchtungssets /
Waschküchenelemente /
Badewannen / Waschbecken /
Duschkabinen

FR Miroirs / Revêtements /
Radiateurs Décoratifs /
Receveurs de douche /
Meubles / Eclairage /
Buanderie / Baignoires /
Lavabo / Parois de douche

Index

Ante Battenti / Wing doors / Schwenktüren / Portes Battantes

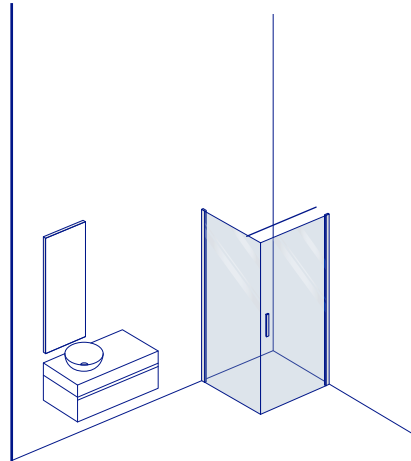

A180	p. 14
Otto	p. 24
Kore	p. 32
Perseo	p. 42
Icaro	p. 48

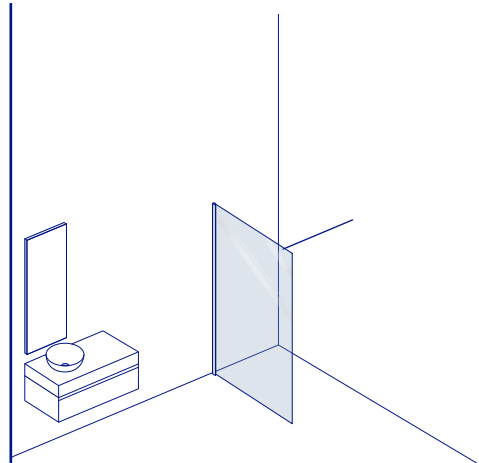
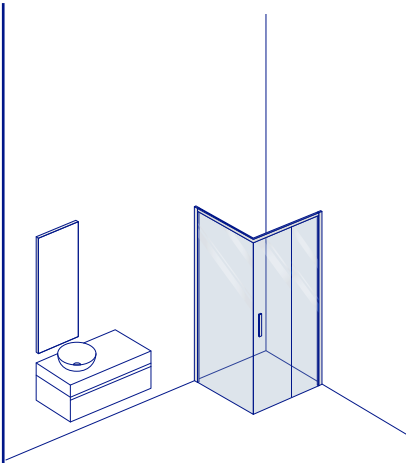
**Ante Scorrevoli / Sliding doors /
Schiebetüren / Portes Coulissantes****Walk-in**

A180	p. 66
Otto	p. 76
Perseo	p. 86
Filo	p. 92
Sirio	p. 106

Separet Elite	p. 120
Separet 8	p. 126
Separet 6	p. 134

Configurazioni standard

EN Standard configurations

DE Standardkonfigurationen

FR Configurations Standard

**Angolo / Corner /
Ecke / Angle**

**Nicchia / Niche /
Nische / Niche**

**Parete / Wall /
Wand / Au mur**

**Ante Battenti /
Wing doors /
Schwenktüren /
Portes Battantes**

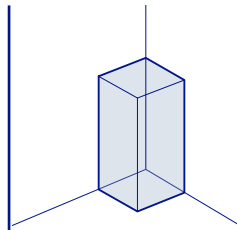

A180
Otto
Kore
Perseo
Icaro

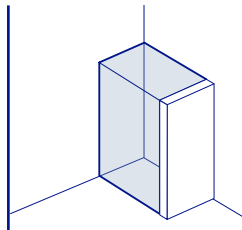

A180
Otto
Kore
Perseo
Icaro

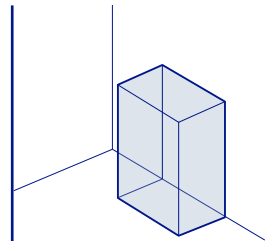

Otto

**Ante Scorrevoli /
Sliding doors /
Schiebetüren /
Portes Coulissantes**

A180
Otto
Perseo
Filo
Sirio

A180
Otto
Perseo
Filo
Sirio

A180
Otto

Walk-in

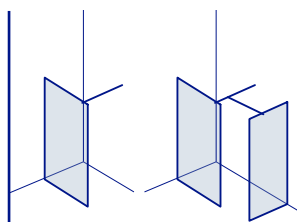

Separet Elite
Separet 8
Separet 6

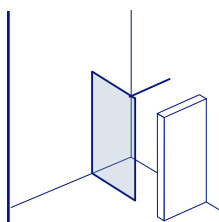

Separet Elite
Separet 8
Separet 6

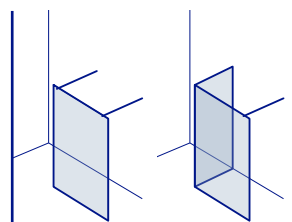

Separet Elite
Separet 8
Separet 6

Configurazioni speciali

EN Special configurations

DE Spezielle Konfigurationen

FR Configurations Spéciales

Lato sagomato / Shaped side / Geformte Seite / Côté découpé	Sottotetto / Sloping ceiling / Unterdach Verbauung / Sous pente	Lato corto / Short side / Kurze Seite / Côté court	Sopramuretto / Above wall additional side / Zusatzseite auf Mauer / Côté additionel sur muret
--	--	---	--

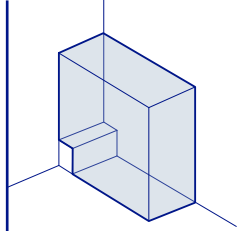

A180
Otto
Kore
Icaro

A180
Otto

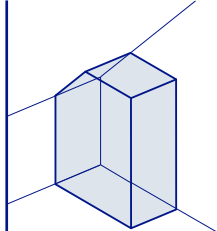

A180
Otto
Kore
Icaro

A180
Otto

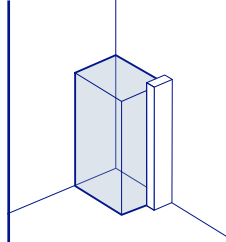

A180
Otto
Kore
Perseo
Icaro

A180
Otto
Perseo
Filo
Sirio

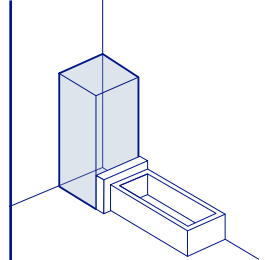

Otto
Perseo
Icaro

Otto
Perseo

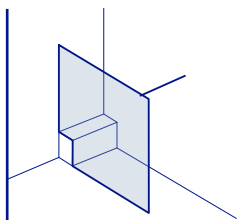

Separet Elite
Separet 8
Separet 6

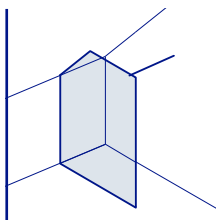

Separet Elite
Separet 8
Separet 6

Trattamenti Vetro

EN Glass treatment

DE Glas-Schutzbehandlungen

FR Traitements du verre



**Vetro trattato / Glass with treatment /
Behandeltes Glas / Verre traité**

**Vetro non trattato / Glass without treatment
Unbehandeltes Glas / Verre non traité**



Anti-calcare / Anti-limescale /
Antikalk / Anti-calcaire



Anti-condensa / Anti-condensation /
Anti-Kondensation / Anti-condensation

Vantaggi / Benefits / Vorteilen / Avantages



Più igienico, limita l'adesione di calcare, batteri e muffe / More hygienic, it limits the adhesion of limescale, bacteria and molds / Hygienisch, da das Anhaften von Kalk, Bakterien und Schimmelpilzen sich einschränkt / Plus hygiénique, limitant l'adhérence du calcaire, des bactéries et des moisissures



Pulizia facile / Easy cleaning /
Leichte Reinigung /
Nettoyage facile



Elevata trasparenza e brillantezza / High transparency and brilliance / Hohe Transparenz und Brillanz / Haute transparence et brillance



Rispetta l'ambiente, riduce l'utilizzo d'acqua e detersivi per la pulizia / Respect the environment, reduce the use of water and detergents for cleaning / Umweltfreundlich, reduziert den Verbrauch von Wasser und Reinigungsmitteln / Respectueux de l'environnement, il réduit l'utilisation d'eau et des produits de nettoyage

Differenze / Differences / Unterschiede / Différences



TIMELESS

Trattamento eseguito in fase di produzione /
Treatment performed in the production phase /
Behandlung während der Produktionsphase /
Traitement effectué en cours de production



SGP - Shower glass protect

Trattamento applicato su vetro già prodotto /
Treatment applied on glass already produced /
Behandlung von bereits hergestelltem Glas /
Traitement appliqué au verre déjà produit



SGP + MORE CARE

Utile a prolungare la durata del trattamento SGP /
Useful to prolong the duration of treatment SGP /
Nützlich, um die Dauer der SGP-Behandlung zu verlängern /
Utile pour prolonger la durée du traitement SGP



Trattamenti disponibili sulle finiture / Treatments available on the finishes / Verfügbare Behandlungen auf Oberflächen / Traitements disponibles sur les finitions

	Trasparente	Satinato	Grigio Europa	Extra Light	Specchiato	Serigrafato Fascia	Piumato	Digital Industry
	<input type="checkbox"/>	<input type="checkbox"/>	<input type="checkbox"/>	<input type="checkbox"/>	<input type="checkbox"/>	<input type="checkbox"/>	<input type="checkbox"/>	<input type="checkbox"/>
	<input type="checkbox"/>							



Pellicola di Protezione Trasparente / Treatments available on these finishes / Transparente Schutzfolie / Film de protection transparent

GSS - Glass safety system



Viene applicata ai vetri, con lo scopo di bloccare, in caso di rottura, la dispersione dei frammenti, evitando che questi colpiscano l'utilizzatore /
The safety film is applied to glass, with the aim of blocking the dispersion of fragments in the event of glass breakage, preventing them from hitting the user /
Es wird auf das Glas aufgetragen, um im Falle eines Bruchs die Dispersion von Glasfragmenten zu vermeiden /
Il est appliqué sur le verre afin de bloquer la dispersion des fragments en cas de bris.

Index Battenti

EN Wing doors index

DE Index Schwenktüren

FR Index Portes Battantes

A180

Pag. 14



Otto

Pag. 24



Kore

Pag. 32



Battenti / Wing doors / Schwenktüren / Portes Battantes

Perseo

Pag. 42



Icaro

Pag. 48



Ante Battenti

EN Wing doors

DE Schwenktüren

FR Portes Battantes

**Cerniera a muro / Wall hinge /
Wandscharniere / Charnières au mur**

A muro /
Wall hinges /
Wandscharniere /
Charnières au mur

A180

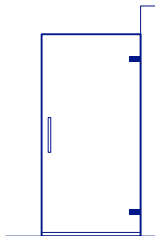

**Cerniera vetro su vetro / Glass-to-glass hinge /
Scharniere zwischen Gläsern /
Charnières verre à verre**

Vetro su vetro /
Glass-to-glass hinges /
Scharniere zwischen Gläsern /
Charnières verre à verre

A180
OTTO

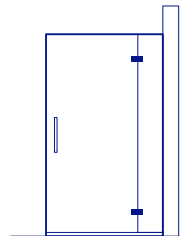

Bilico a muro /
Wall-mounted pivot hinges /
Pivot-Wandscharniere /
Pivotant au mur

KORE
PERSEO

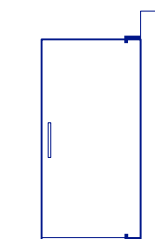

Profilo cerniera a muro /
Wall hinge profile /
Wandscharnierprofil /
Profil charnière murale

ICARO

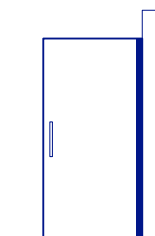

Profilo cerniera vetro su vetro /
Glass-to-glass hinge profile /
Scharnierprofil zwischen Gläsern /
Profil charnière verre à verre

ICARO

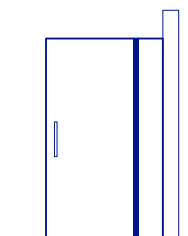

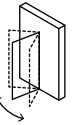

A180	↑	H.210cm	 180°
	↓	Th. 8mm	

A180

Configurazioni / Configurations / Konfigurationen / Configurations

Varianti / Variants / Varianten / Variantes

Standard

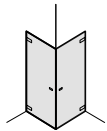

ANG Q-R 2AB

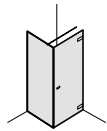

ANG Q-R 1AB+1LF

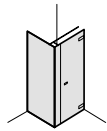

ANG Q-R 1AA+1LF

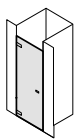

NIC 1AB

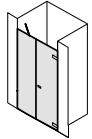

NIC 1AA

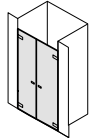

NIC 2SL

Plus

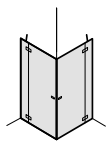

ANG Q-R 2AB

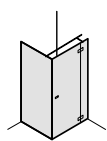

ANG Q-R 1AB+1LF

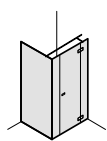

ANG Q-R 1AA+1LF

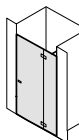

NIC 1AB

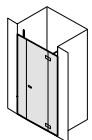

NIC 1AA

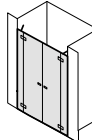

NIC 2SL

Special

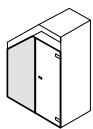

STT

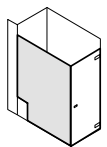

1LF-SAG

Maniglia / Handles / Griffe / Poignées



A180 standard



"G" optional

Profili / Profiles / Profilen / Profils



Argento Lucido



Alublack



Colors Arblu



Metal e Metal Brushed

Vetri / Glasses / Gläser / Verres



Trasparente



Satinato



Grigio Europa



Extra Light



Specchiato



A180





A180





A180





A180



Il vetro si adegua alla forma dello spazio: non ci sono limiti alle personalizzazioni

EN Glass adapts itself to the space shapes: there are no limits to customizations.

DE Das Glas passt sich an der Form der Ambiente an: es gibt sehr viele Möglichkeiten für eine individuelle Gestaltung

FR Le verre s'adapte à la forme de l'espace : il n'y a pas de limites à la personnalisation.

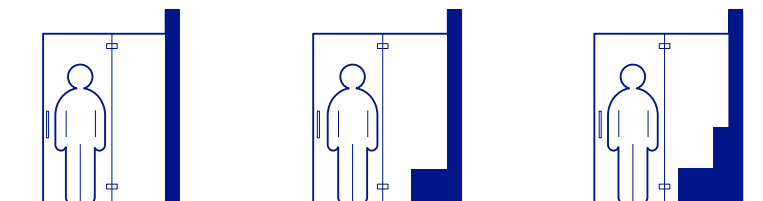

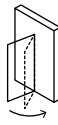
<h1>Otto</h1>	↑	H.205cm	
	↓	Th. 8mm	

Otto

Configurazioni / Configurations / Konfigurationen / Configurations

Varianti / Variants / Varianten / Variantes

Standard

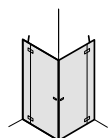

ANG Q-R 2AB

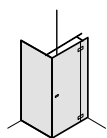

ANG Q-R 1AB+1LF

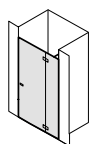

NIC 1AB

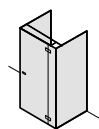

PAR 1AB-FRO

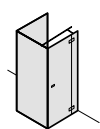

PAR 1AB-LAT

Special

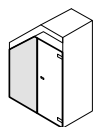

STT

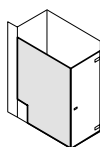

1LF-SAG

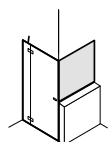

1LA - SMU

Maniglia / Handles / Griffe / Poignées



"E" standard



"G" optional

Profili / Profiles / Profilen / Profils



Argento Lucido



Alublack



Colors Arblu



Metal e Metal Brushed

Vetri / Glasses / Gläser / Verres



Trasparente



Satinato



Grigio Europa



Extra Light



Specchiato



Serigrafato Fascia



Otto





Otto





Otto



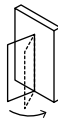

Battenti / Wing doors / Schwenktüren / Portes Battantes

<h1>Kore</h1>	↑	H.200cm	 90°
	↓	Th. 6mm / 8mm	

Kore

Configurazioni / Configurations / Konfigurationen / Configurations

Varianti / Variants / Varianten / Variantes

Standard

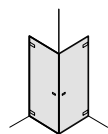

ANG Q-R 2BL

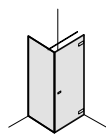

ANG Q-R 1BL+1LF

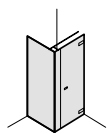

ANG Q-R 1BA+1LF

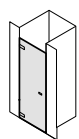

NIC 1BL

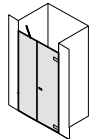

NIC 1BA

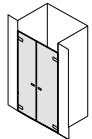

NIC 2BL

Special

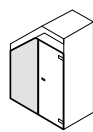

STT

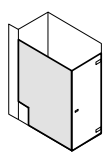

1LF-SAG

Maniglia / Handles / Griffe / Poignées



Kore standard

Profili / Profiles / Profilen / Profils



Argento Lucido



Alublack



Colors Arblu



Metal e Metal Brushed

Vetri / Glasses / Gläser / Verres



Trasparente



Satinato



Grigio Europa



Extra Light



Specchiato







Kore





Kore





Kore



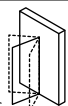

<h1>Perseo</h1>	↑	H.200cm	 180°
	↓	Th. 6mm	

Perseo

Configurazioni / Configurations / Konfigurationen / Configurations

Varianti / Variants / Varianten / Variantes

Standard

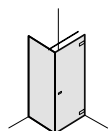

ANG Q-R
1BL+1LF

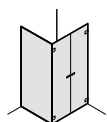

ANG Q-R
2SL+1LF

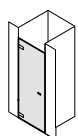

NIC 1BL

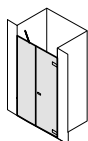

NIC 1BA

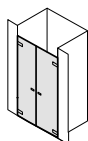

NIC 2SL

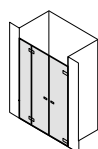

NIC 2SA

Special

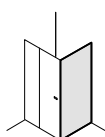

1LA

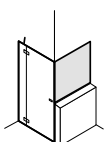

1LA - SMU

Maniglia / Handles / Griffe / Poignées



"R"
standard

Profili / Profiles / Profilen / Profils



Argento
Lucido

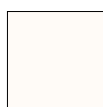

Bianco
Seta

Vetri / Glasses / Gläser / Verres



Trasparente



Satinato



Grigio
Europa



Extra
Light



Specchiato



Piumato



Serigrafato
Fascia



Perseo





Perseo



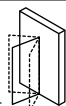

<h1>Icaro</h1>	↑	H.200cm	 90°/180°
	↓	Th. 6mm	

Icaro

Configurazioni / Configurations / Konfigurationen / Configurations

Varianti / Variants / Varianten / Variantes

Standard

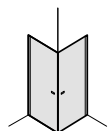

ANG Q-R 2AB

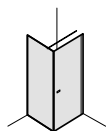

ANG Q-R 1AB+1LF

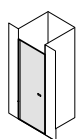

NIC 1AB

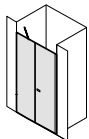

NIC 1AA

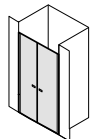

NIC 2SL

Plus

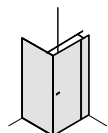

ANG Q-R 1AB+1LF

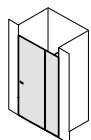

NIC 1AB

Special

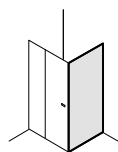

1LA

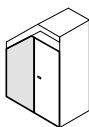

STT

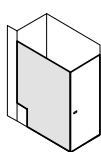

1LF - SAG

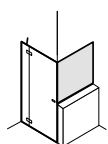

1LA - SMU

Maniglia / Handles / Griffe / Poignées



"D" standard

Profili / Profiles / Profilen / Profils



Argento Lucido



Alublack



Colors Arblu



Metal e Metal Brushed

Vetri / Glasses / Gläser / Verres



Trasparente



Satinato



Grigio Europa



Extra Light



Specchiato



Piumato



Serigrafato Fascia



Icaro





Icaro





Icaro





Battenti / Wing doors / Schwenktüren / Portes Battantes

Varianti sottotetto (STT)

EN Sloping ceiling variants

DE Unterdach Varianten

FR Sous pente variantes

Icaro

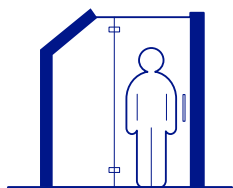

Cerniera vetro su vetro /
Glass to glass hinge /
Scharniere zwischen Gläsern /
Charnières verre à verre

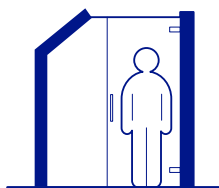

Cerniera a muro /
Wall hinge /
Wandscharniere /
Charnières au mur

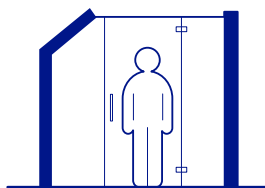

Cerniera vetro su vetro asimmetrico /
Glass hinge on asymmetrical glass /
Glasscharnier auf asymmetrischem Glas /
Charnière en verre sur verre asymétrique

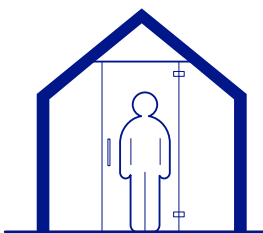



Icaro

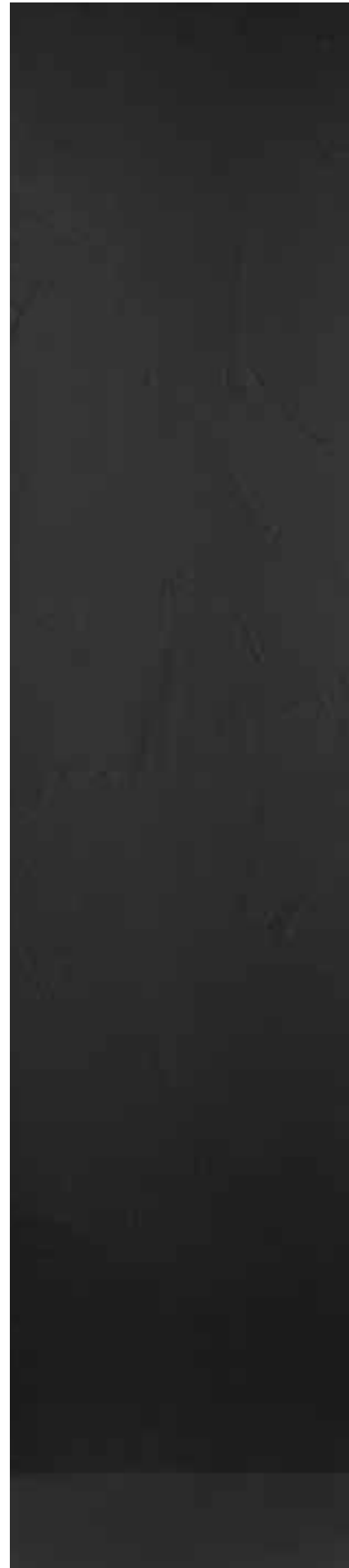



Icaro

Icaro

IT La doccia con apertura battente, dalle linee decise ed attuali.

EN The shower enclosure with hinged opening, with decisive and current lines.

DE Die Dusche mit Schwenktüren, mit modernen und zeitgemäßen Linien

FR La douche avec ouverture à charnière, aux lignes fortes et contemporaines

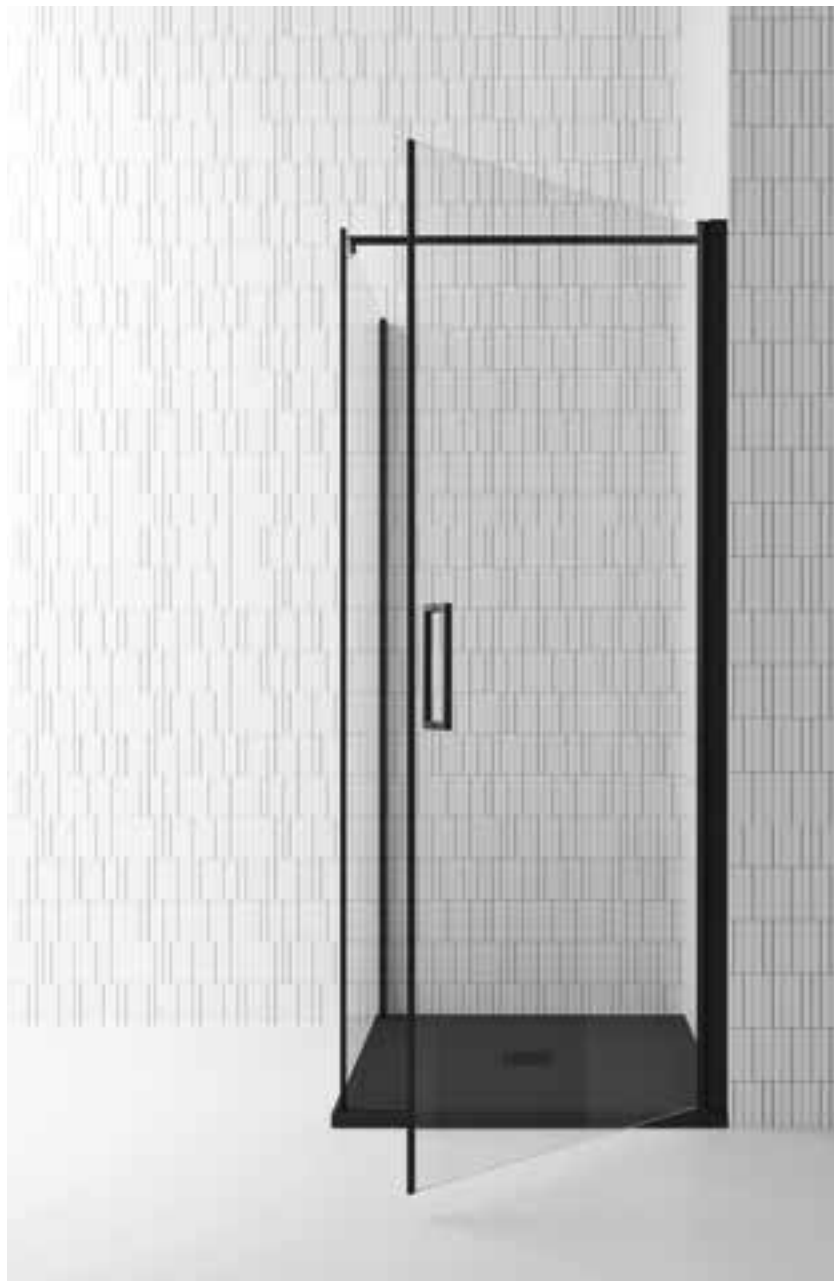
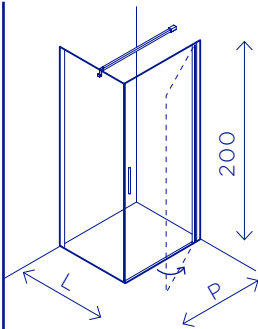

Icaro Plus

IT Per riempire gli spazi più grandi, ci vuole una marcia in più.

EN To fill the largest spaces, it takes an extra gear.

DE Um das Bad mit Effizienz zu gestalten, braucht man ein absolutes "Plus".

FR Pour remplir les plus grands espaces, il faut un équipement supplémentaire.

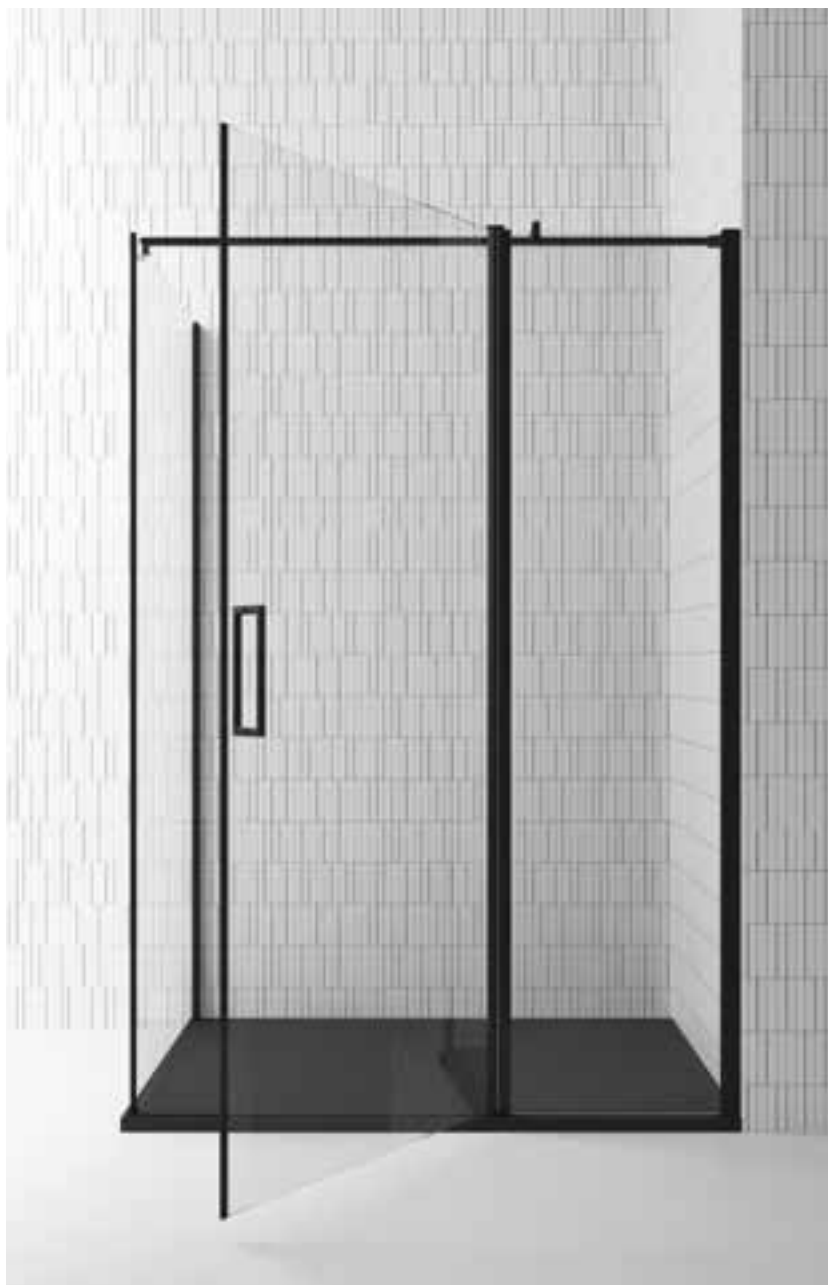
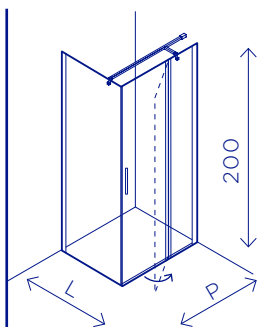

Index Scorrevoli

EN Sliding doors index

DE Index Schiebetüren

FR Index Portes Coulissantes

A180

Pag. 66



Otto

Pag. 76



Perseo

Pag. 86



Filo

Pag. 92



Sirio

Pag. 106



Ante Scorrevoli

EN Sliding doors

DE Schiebetüren

FR Portes Coulissantes

**Senza telaio / Without frame /
Ohne Rahmen / Sans cadre**

A180
OTTO

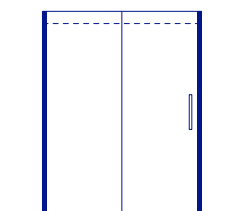

**Con telaio / With frame /
Mit Rahmen / Avec cadre**

Senza profilo inferiore /
Frame without bottom profile /
Ohne Unterprofil /
Sans profil inférieur

PERSEO

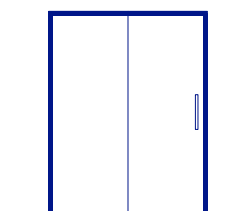

Con profilo inferiore ribassato /
Low profile frame /
Mit geringem Profil /
Avec profil bas

FILO
SIRIO

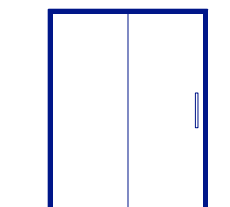



A180		H.210cm
		Th. 8mm

A180

**Configurazioni / Configurations /
Konfigurationen / Configurations**
Varianti / Variants / Varianten / Variantes

Standard

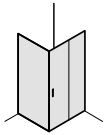
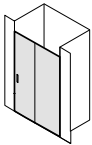
ANG Q-R
1AS+1LF

NIC 1AS

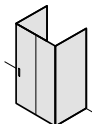

PAR 1AS

Special

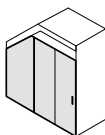

STT

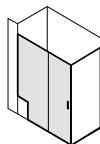

1LF -SAG

Maniglia / Handles / Griffe / Poignées

"G"
standard

Profili / Profiles / Profilen / Profils

Argento
Lucido

Alublack

Colors
ArbluMetal e
Metal
Brushed

Vetri / Glasses / Gläser / Verres



Trasparente



Satinato

Grigio
EuropaExtra
Light

Specchiato



A180







Possibilità di apertura e chiusura dell'anta per modello / Possibility of opening and closing the door by model / Möglichkeiten zum Türöffnen und -schließen nach Modell / Possibilités d'ouverture et de fermeture de la porte par modèle

	A180	Otto	Perseo	Filo	Sirio
Chiusura standard / Standard closure / Standardverschluss / Fermeture standard				<input type="radio"/>	<input type="radio"/>
Apertura Soft-close / Soft-close opening / Soft-Close Öffnung / Ouverture Soft-Close		<input type="radio"/>			
Chiusura Soft-close / Soft-close closure / Soft-Close Verschluss / Fermeture Soft-Close		<input type="radio"/>	<input type="radio"/>		
Chiusura Automatica anta / Automatic Door Close System / Automatischer Türverschluss / Fermeture automatique des portes	<input type="radio"/>				

Chiusura Soft-close

EN Soft-close closure
DE Soft-Close Verschluss
FR Fermeture Soft-Close



IT Quando la chiusura è soft la sicurezza è garantita.

EN When the door closes softly, safety is guaranteed.

DE Das Soft-Close System gewährt einen zusätzlichen Schutz beim Einsteigen.

FR Lorsque la serrure est soft, la sécurité est garantie.

Chiusura Automatica anta

EN Automatic Door Close System
DE Automatischer Türverschluss
FR Fermeture automatique des portes



IT La chiusura è dolcemente accompagnata, basta solo una leggera spinta.

EN The closing of the door is gently accompanied, just a slight push will be enough.

DE Die Schließung erfolgt sanft und dezent, hierzu reicht ein leichter Touch.

FR La fermeture est accompagnée en toute facilité, il suffit d'une légère pression.



A180





A180





Otto	↑	H.205cm
	↓	Th. 8mm

Otto

Configurazioni / Configurations / Konfigurationen / Configurations

Varianti / Variants / Varianten / Variantes

Standard

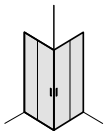

ANG Q-R 2AS

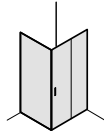

ANG Q-R 1AS+1LF

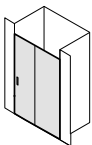

NIC 1AS

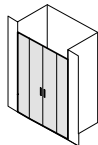

NIC 2AS

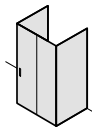

PAR 1AS

Special

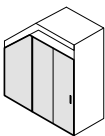

STT

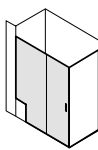

1LF - SAG

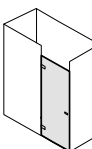

1AS

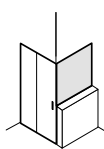

1LA - SMU

Maniglie / Handles / Griffe / Poignées



"E" standard



"G" optional

Profili / Profiles / Profilen / Profils



Argento Lucido



Alublack



Colors Arblu



Metal e Metal Brushed

Vetri / Glasses / Gläser / Verres



Trasparente



Satinato



Grigio Europa



Extra Light



Specchiato



Serigrafato Fascia



Otto





Otto





Otto





Otto



<h1>Perseo</h1>	↑	H.200cm
	↓	Th. 6mm

Perseo

Configurazioni / Configurations / Konfigurationen / Configurations

Varianti / Variants / Varianten / Variantes

Standard

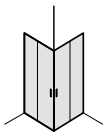

ANG Q-R 2AS

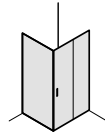

ANG Q-R 1AS+1LF

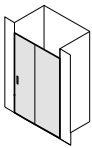

NIC 1AS

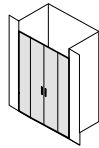

NIC 2AS

Special

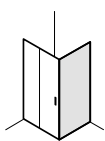

1LA

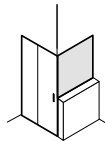

1LA - SMU

Maniglie / Handles / Griffe / Poignées



"R" standard



"W" optional

Profili / Profiles / Profilen / Profils



Argento Lucido



Bianco Seta

Vetri / Glasses / Gläser / Verres



Trasparente



Satinato



Grigio Europa



Extra Light



Specchiato



Piumato



Serigrafato Fascia



Perseo





Perseo



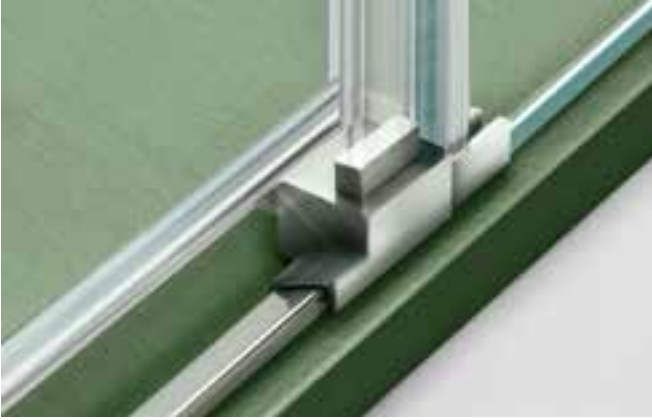

<h1>Filo</h1>	↑	H.200cm
	↓ H	Th. 6mm

Filo

Configurazioni / Configurations / Konfigurationen / Configurations

Varianti / Variants / Varianten / Variantes

Standard

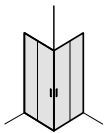

ANG Q-R 2AS

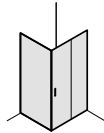

ANG Q-R 1AS+1LF

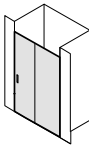

NIC 1AS

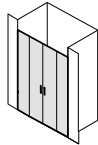

NIC 2AS

Maniglie / Handles / Griffe / Poignées



"M" standard



"L" optional

Profili / Profiles / Profilen / Profils



Argento Lucido



Alublack



Colors Arblu



Metal e Metal Brushed

Vetri / Glasses / Gläser / Verres



Trasparente



Satinato



Grigio Europa



Extra Light



Specchiato



Piumato





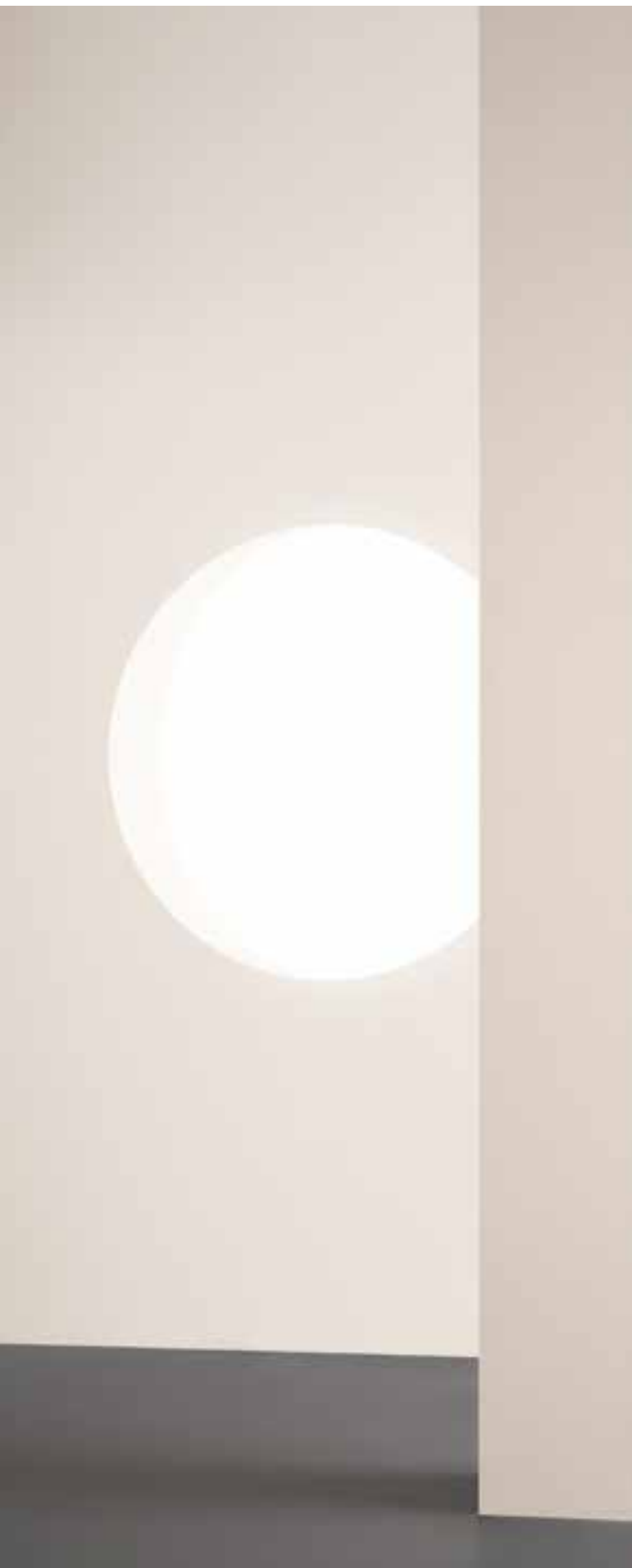

Filo









Filo





Filo





Filo





<h1>Sirio</h1>	↑	H.200cm
	↓	Th. 6mm

Sirio

Configurazioni / Configurations / Konfigurationen / Configurations

Varianti / Variants / Varianten / Variantes

Standard

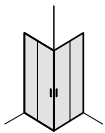

ANG Q-R 2AS

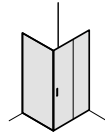

ANG Q-R 1AS+1LF

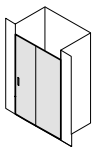

NIC 1AS

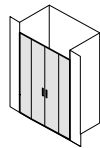

NIC 2AS

Maniglie / Handles / Griffe / Poignées



"W" standard



"L" optional



"M" optional

Profili / Profiles / Profilen / Profils



Argento Lucido



Alublack

Vetri / Glasses / Gläser / Verres



Trasparente



Satinato



Grigio Europa



Extra Light



Specchiato



Piumato



Serigrafato Fascia



Sirio





Sirio





Sirio





Sirio





Sistema di compensazione tradizionale

EN Traditional compensation system

DE Traditionelles Kompensationssystem

FR Système de compensation traditionnel

Disponibile per /
Available for /
Erhältlich für /
Disponible pour

PERSEO



Sistema di compensazione “Arblu”

EN Arblu compensation system

DE Arblu Kompensationsystem

FR Système de compensation Arblu

Disponibile per /
Available for /
Erhältlich für /
Disponible pour

A180
OTTO
FILO
SIRIO



Index

Walk-in

Separet Elite

Pag. 120



Separet 8

Pag. 126



Separet 6

Pag. 134



Walk-in

Con profilo verticale a muro /
With vertical wall profile /
Mit senkrechtem Wandprofil /
Avec profilé mural vertical

Separet 8
Separet 6

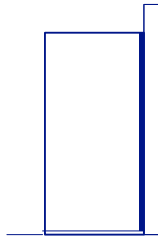

Con morsetti a muro /
With wall clamps /
Mit Glasklemme Wand-Glas /
Avec clip au mur

Separet Elite

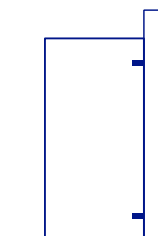

Separet Elite



H.205cm



Th. 8mm

Configurazioni / Configurations / Konfigurationen / Configurations

Varianti / Variants / Varianten / Variantes

Standard

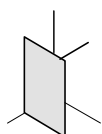

C4

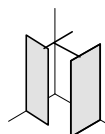

C5

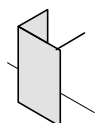

C2

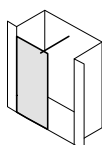

C4

Special

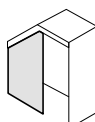

STT

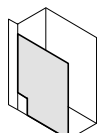

1LF - SAG

Elementi opzionali / Optional elements / Wahlfreie
elemente / Éléments en option

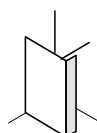
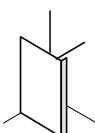

Braccetti / Arms / Wandstütze / Bras au mur



"S"
Standard

Profili / Profiles / Profilen / Profils



Argento
Lucido



Alublack



Colors
Arblu



Metal e
Metal
Brushed

Vetri / Glasses / Gläser / Verres



Trasparente



Satinato



Grigio
Europa



Extra
Light



Specchiato



Serigrafato
Fascia



Walk-in

Separet Elite





Walk-in





Vetro di contenimento

- EN** Containment glass
DE Zusätzliche Glasschiebe
FR Verre de retour

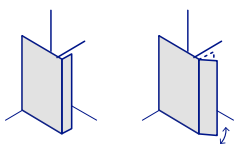

Con vetro di contenimento singolo fisso o mobile / With single containment glass / Mit fester oder beweglicher zusätzlichen Glasschiebe, / Avec simple verre de retour fixe ou mobile

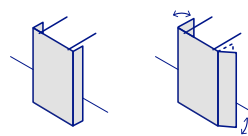

Con vetro di contenimento doppio fisso o mobile / With double containment glass / Mit fester oder beweglicher doppelten Glasschiebe / Avec simple double verre de retour fixe ou mobile

<h1>Separet 8</h1>	↑	H.205cm
	↓	Th. 8mm

Separet 8

Configurazioni / Configurations / Konfigurationen / Configurations

Varianti / Variants / Varianten / Variantes

Standard

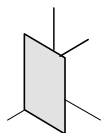

C4

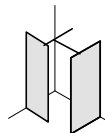

C5

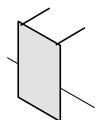

C1

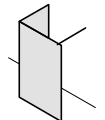

C2

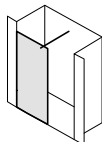

C4

Special

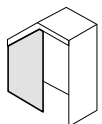

STT

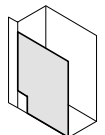

1LF - SAG

Elementi opzionali / Optional elements / Wahlfreie elemente / Éléments en option

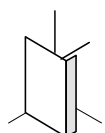
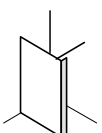

Braccetti / Arms / Wandstütze / Bras au mur

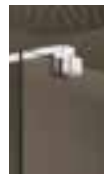

"S" Standard

Profili / Profiles / Profilen / Profils



Argento Lucido



Alublack



Colors Arblu



Metal e Metal Brushed

Vetri / Glasses / Gläser / Verres



Trasparente



Satinato



Grigio Europa



Extra Light



Specchiato



Serigrafato Fascia



Digital Industry



Walk-in









Walk-in

Braccetti con appendino

EN Arms with hanger

DE Stütze mit Haken

FR Bras avec crochet

Separet 8

“S” - 8mm

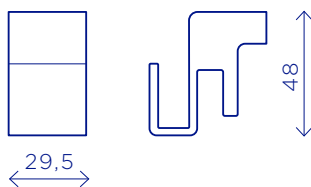

“Q” - 6mm

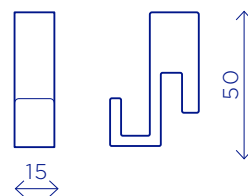

Disponibilità braccetto / Arms availability / Verfügbarkeit Wandstütze / Disponibilité Bras

	A180	Otto	Kore	Icaro	Separet Elite	Separet 8	Separet 6
“S”	<input type="checkbox"/>	<input type="checkbox"/>	<input type="checkbox"/>		<input type="checkbox"/>	<input type="checkbox"/>	
“Q”				<input type="checkbox"/>			<input type="checkbox"/>



<h1>Separet 6</h1>	↑ H.200cm
	↓ Th. 6mm

Separet 6

Configurazioni / Configurations / Konfigurationen / Configurations

Varianti / Variants / Varianten / Variantes

Standard

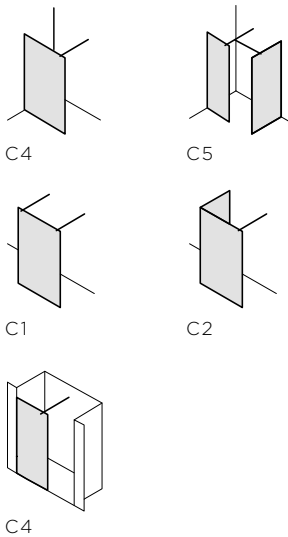

Special

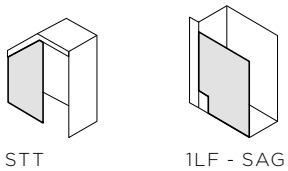

Elementi opzionali / Optional elements / Wahlfreie elemente / Éléments en option

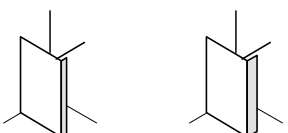

Braccetti / Arms / Wandstütze / Bras au mur



"Q" Standard

Profili / Profiles / Profilen / Profils



Vetri / Glasses / Gläser / Verres





Walk-in

Separet 6



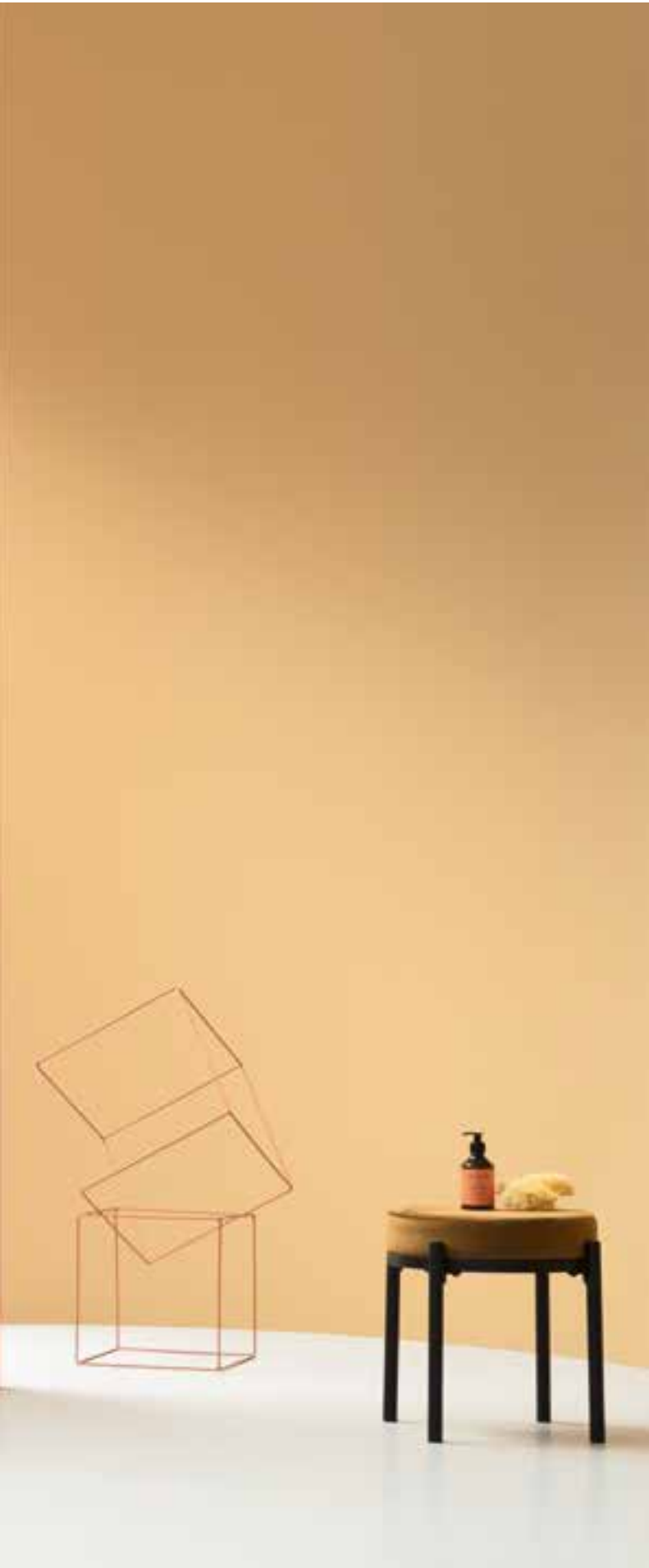

Walk-in





Walk-in

Personalizza la tua doccia

EN Personalize your shower

DE Gestalten Sie Ihre Dusche nach Wunsch

FR Personnalisez votre douche

Argento lucido

Pag. 142



Alublack

Pag. 144



Laccati

Pag. 146



Metal

Pag. 148



Argento lucido

EN Silver brill

DE Silber glanz

FR Argent brillant

IT La più classica delle finiture per un angolo senza tempo

EN The most classic of finishes for a timeless corner

DE Die klassischste aller Varianten für eine zeitlose Ecklösung

FR La plus classique des finitions pour un angle sans âge

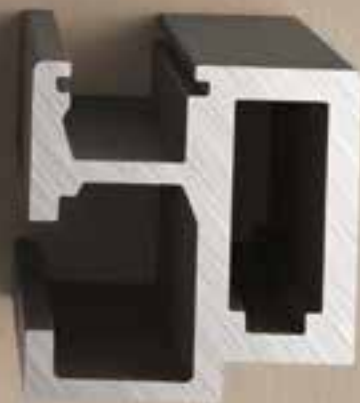

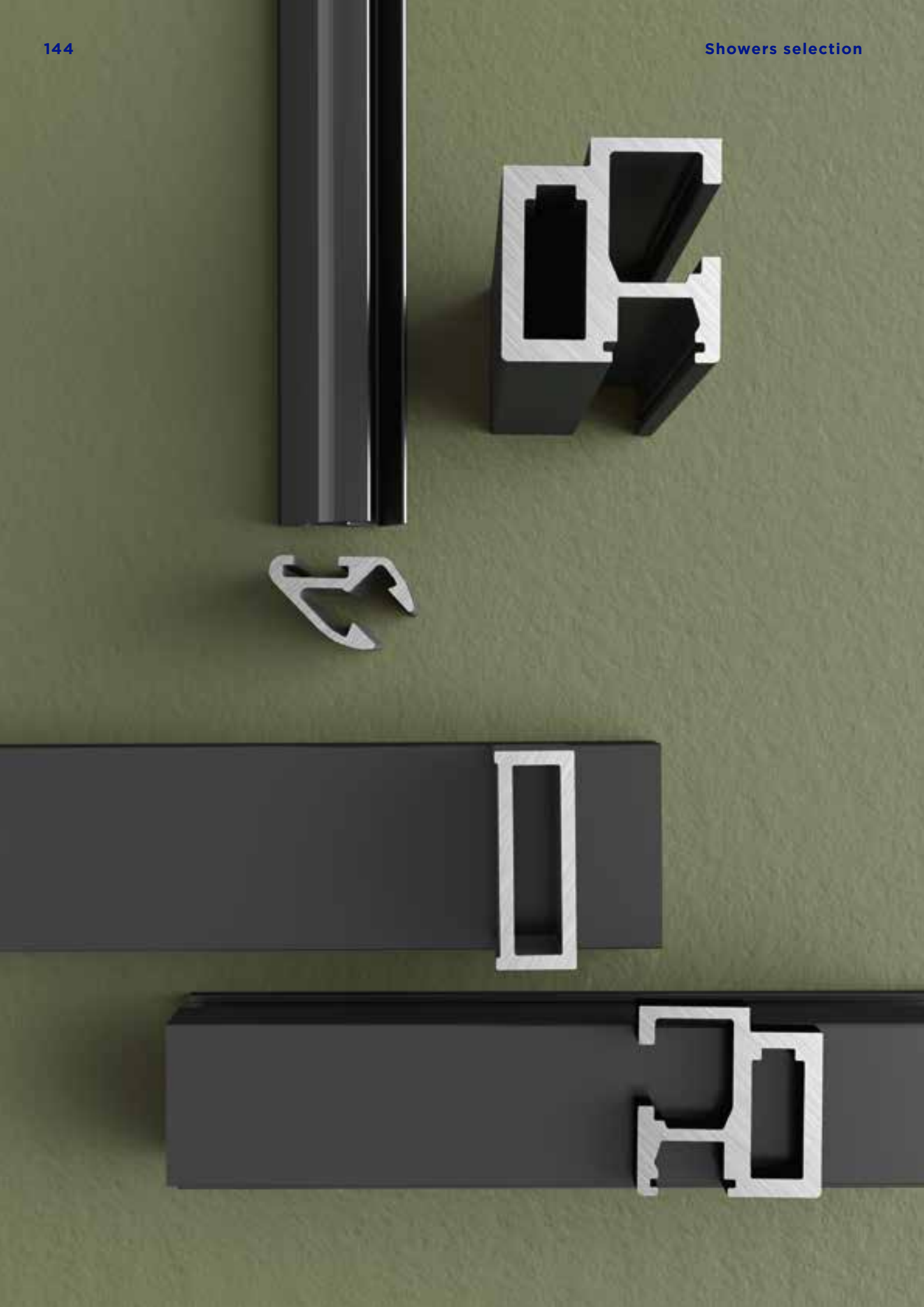

Alublack

IT Uno stile deciso ed attuale che definisce la stanza da bagno di carattere.

EN A decisive and current style that defines the bathroom with character.

DE Ein betonender, moderner Stil, der das Bad mit Charakter definiert.

FR Un style fort et contemporain qui définit la salle de bains de caractère

Laccati

EN Lacquered colors

DE Lackierte

FR Laqués

IT Non c'è limite all'immaginazione, il colore che fa la differenza

EN There is no limit to the imagination, it is the color that makes the difference

DE Grenzenfreiheit bei der Kreationsgestaltung, die Farbe macht den Unterschied

FR L'imagination n'a pas de limite, c'est la couleur qui fait la différence



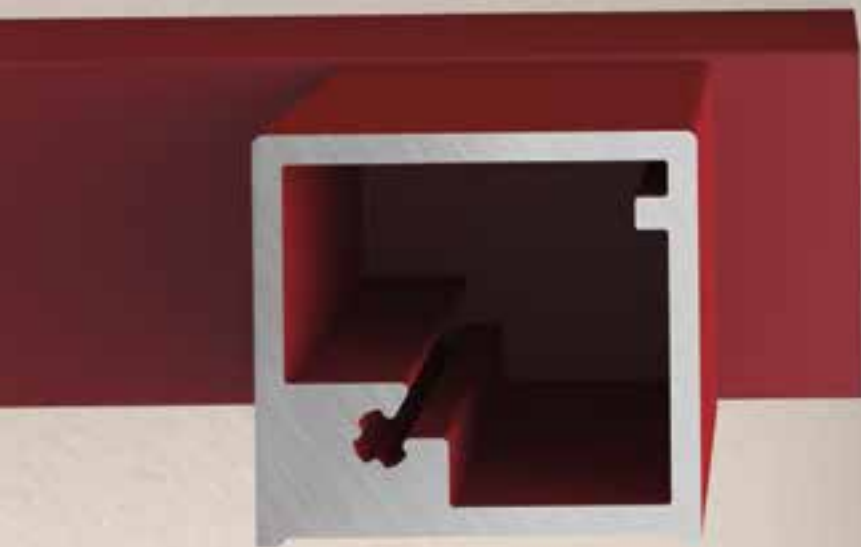



Metal

IT È il metallo che ispira, la matericità e le cromie che disegnano la doccia nel dettaglio.

EN It is the metal that inspires, the materiality and the colors that draw the shower in detail

DE Es ist das Metall, das inspiriert, die Materialien und die Farben bestimmen die Dusche im Detail.

FR C'est le métal qui inspire, la matérialité et les couleurs qui dessinent la douche en détail.

Metal
Brushed
Black
MB3005



Metal
Black
ME3005



Metal
Brushed
Bronze
MB3003



Metal
Bronze
ME3003



Metal
Brushed
Gold
MB3002



Metal
Gold
ME3002



Metal
Brushed
Graphite
MB3004



Metal
Graphite
ME3004



Metal
Brushed
Silver
MB3001



Metal
Silver
ME3001



**Legenda configurazioni / Configuration legend /
Konfigurationslegende / Légende des configurations**

ANG	Angolo / Corner / Ecke / Angle
NIC	Nicchia / Niche / Nische / Niche
PAR	Parete / Wall / Wand / Mur
Q	Quadrato / Squared / Quadratisch / Carré
R	Rettangolare / Rectangular / Rechteckig / Rectangulaire
1AB	1 Anta Battente / 1 Wing door / 1 Schwenktür / 1 Porte battante
2AB	2 Ante Battenti / 2 Wing doors / 2 Schwenktüren / 2 Portes battantes
1AS	1 Anta Scorrevole / 1 Sliding door / 1 Schiebetür / 1 Porte coulissante
2AS	2 Ante Scorrevoli / 2 Sliding doors / 2 Schiebetüren / 2 Portes coulissantes
1LF	1 Lato Fisso / 1 Fixed Side / 1 Fixteil / 1 Côté Fixe
1LA	1 Lato Aggiuntivo / 1 Additional Side / 1 Zusatzseite / 1 Côté Additionnel
2SL	2 Ante Saloon / 2 Saloon Doors / 2 Pendeltüren / 2 Portes Saloon
2SA	2 Ante Saloon Asimmetrico / 2 Asymmetric Saloon Doors / 2 Asymmetrische Pendeltüren / 2 Portes Saloon Asymétriques
1BL	1 Ante Bilico / 1 Pivot Door / 1 Pivot-Drehtür / 1 Porte Pivotante
1BA	1 Anta Bilico Asimmetrico / 1 Asymmetric Pivot Door / 1 Asymmetrische Pivot-Drehtür / 1 Porte pivotante Asymétrique
1AA	1 Anta Battente Asimmetrico / 1 Asymmetric Wing door / 1 Asymmetrische Schwenktür / 1 Porte battante Asymétrique
FRO	Frontale / Front / Frontales / Frontal
LAT	Laterale / Lateral / Seitliches / Latéral
SMU	Sopramuretto / Top wall / Zusatzseite auf Mauer / Cote additionnel sur le muret
STT	Sottotetto / Under roof / Unterdach Verbauung / Sous pente



ISO 9001
n° IT263648

IT ARBLU SRL ha un sistema di gestione qualità certificato secondo la norma

EN ARBLU SRL has a quality management system certified according to the regulation

DE Qualitätssystem von ARBLU SRL wurde gemäß folgender Norm zertifiziert

FR ARBLU SRL a la certification du système de gestion de la qualité selon la norme



ISO 45001:2018
n° IT292822/UK -1

IT ARBLU SRL ha un sistema di gestione sicurezza certificato secondo la norma

EN ARBLU SRL has a safety management system certified according to the regulation

DE Sicherheitssystem von ARBLU SRL wurde gemäß folgender Norm zertifiziert

FR ARBLU SRL a la certification du système de gestion la qualité selon la norme



DAP
Dichiarazione Ambientale di Prodotto

IT L'EPD, Environmental Product Declaration, o DAP, Dichiarazione Ambientale di Prodotto, è una dichiarazione ambientale certificata volontaria. La valutazione dell'impatto ambientale e delle risorse utilizzate è possibile grazie all'analisi del Ciclo di Vita (LCA, Life Cycle Assessment) del prodotto, prendendo in esame tutte le fasi che vanno dall'estrazione delle materie prime a quelle di trasporto, fabbricazione e smaltimento. Ad ottenere questa importante certificazione sono stati i prodotti firmati Arblu più significativi tra i box doccia con telaio, semitelaio e senza telaio.

EN L'EPD, Environmental Product Declaration, or DAP, it is a voluntary certified environmental declaration. The assessment of the environmental impact and the resources used is possible thanks to the analysis of the Life Cycle (LCA, Life Cycle Assessment) of the product, taking into examination of all the phases ranging from the extraction of raw materials to those of transport, manufacture and disposal. This important certification was obtained by the most significant Arblu products among the shower enclosures with frame, half frame and without frame.

DE Die EPD, Environmental Product Declaration, oder DAP-Dichiarazione Ambientale di Prodotto, ist eine zertifizierte freiwillige Umwelt-Produktklärung. Die Bewertung der Umweltauswirkungen und der verwendeten Ressourcen ist dank der Lebenszyklusbewertung (LCA, Life Cycle Assessment) des Produkts möglich, wobei alle Phasen von der Gewinnung von Rohstoffen bis hin zu Transport, Herstellung und Entsorgung berücksichtigt werden. Diese wichtige Erklärung ist für die wertvollsten Arblu-Produkte unter gerahmte, teilgerahmte und rahmenlose Duschtrennungen verfügbar.

FR La Déclaration Environnementale de Produit (EPD-Environmental Product Declaration / DAP-Dichiarazione Ambientale di Prodotto) est une déclaration environnementale certifiée volontaire. La valuation de l'impact environnemental et des ressources utilisées est possible grâce à l'analyse du cycle de vie (LCA, Life Cycle Assessment) du produit, en prenant en considération toutes les phases qui vont de l'extraction des matières premières au transport, à la fabrication et à l'écoulement. Ce sont des parois de douche avec cadre, semi-encadrées ou sans cadre qui, parmi les produits griffés Arblu les plus significatifs, ont obtenu cette importante certification.



EN Not published Italian Patent Application n° 102022000001946. No provisional protection. No rights derivable.

DE Unveröffentlichte italienische Patentanmeldung Nr. 102022000001946. Kein vorläufiger Schutz. Keine Rechte ableitbar.

AD Brunella Vaccher
PHOTO Fotografica
STYLIST Maura Santarossa
GRAFICA Genny Canton Studio
PRE PRINT Luce Group
PRINT Grafiche Antiga

IT Arblu Srl si riserva il diritto in qualsiasi momento e senza alcun preavviso di effettuare le modifiche che riterrà più opportune. Tutte le fotografie, immagini e testi contenuti nel presente stampato sono di proprietà dell'Azienda che si riserva ogni diritto di utilizzo, con divieto ai terzi di riproduzione e pubblicazione.

EN Arblu Srl is entitled to improve its products at any time without notice. Every picture, image and text in this catalogue belongs to the Manufacturer who also owns all rights of use thereof. Reproduction and publication of any part of this catalogue is strictly forbidden.

DE Arblu Srl behält sich das Recht vor, in jedem Moment und ohne Voranmeldung, zweckmäßige Änderungen vorzunehmen. Alle Fotos, Abbildungen und Texte, welche in diesen Unterlagen erscheinen, sind Eigentum der Firma, welche sich das Nutzrecht, mit Verbot der Wiedergabe und Herausgabe Dritter, vorbehalten.

FR Arblu Srl se réserve le droit d'apporter, à tout moment et sans préavis, tous les changements qu'elle jugera nécessaires. Les photographies, les images et les textes que contient le présent catalogue sont la propriété d'Arblu srl qui se réserve tous les droits d'utilisation. Toute reproduction et toute publication par un tiers sont interdites.

Arblu srl
via Fossaluzza, 5
33074 Fontanafredda PN
Italy
tel. +39 0434 5997
fax +39 0434 599759
info@arblu.it

Arblu Export
ph. +39 0434 599799
export@arblu.it
www.arblu.com

Arblu srl

**via Fossaluzza, 5
33074 Fontanafredda PN
Italy
T. +39 0434 5997
F. +39 0434 599759
info@arblu.it**

**Arblu Export
P. +39 0434 599799
export@arblu.it**

www.arblu.com